

**CHAMBERLAIN**

**6  
in 1**

**EDUCATIONAL  
SOLAR KIT**



Instruction Manual  
Montage Anleitung  
Mode d'emploi  
Montagehandleiding

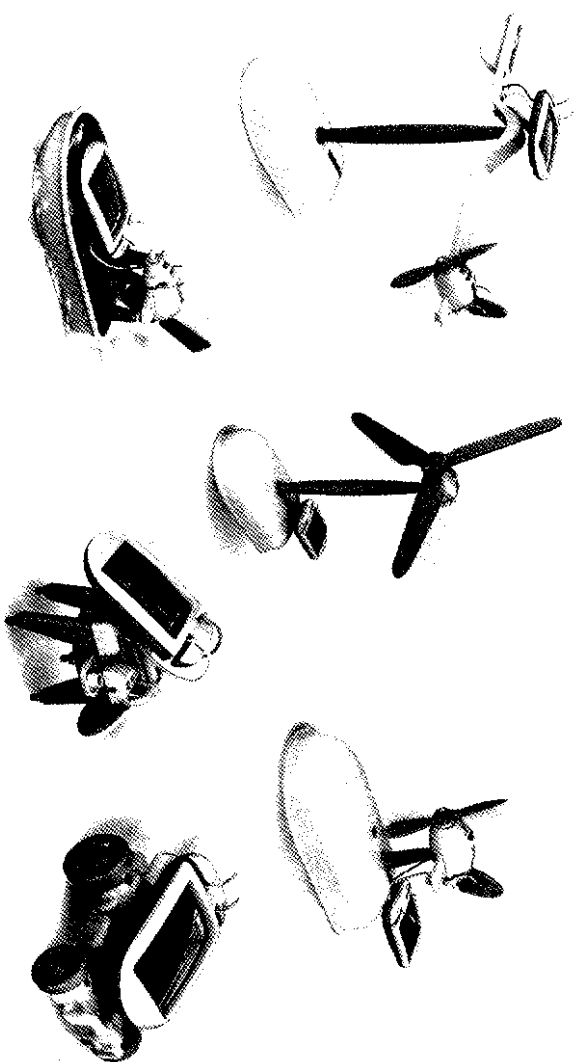

**WARNING**

Choking hazards  
Small parts  
Not for children  
under 3 years



**WARNUNG**

Erstickungsgefahr  
Kleinteile  
Nicht für Kinder  
unter 3 Jahren



**ATTENTION**

Contient des éléments  
petits et pointus  
Convient pas aux enfants  
moins de 3 ans.



**WAARSCHUWING**

Versluitingsgevaar  
Niet voor kinderen  
ouder dan 3 jaar



Solar windmill  
Solar Windmühle  
Eolienne solaire  
Solar windmolen



Solar plane  
Solar Flugzeug  
Avion solaire  
Solar vliegtuig



Solar airboat  
Solar Propellerboot  
Hydroglisseur solaire  
Solar propellerboot



Solar revolving plane  
Solar drehende Flugzeug  
Avion solaire tournant  
Rotierend vliegtuig

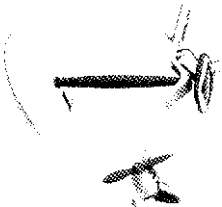

Solar puppy  
Solar Hündchen  
Chien solaire  
Solar puppy hond



Solar car  
Solar Auto  
Voiture solaire  
Solar auto



**WARNING**  
Choking hazards  
Small parts  
Not for children  
under 3 years

**ATTENTION**  
Contient des éléments  
de petite taille. Ne  
convient pas aux enfants  
moins de 3 ans.

**WARNUNG**  
Erstickungsgefahr  
Kleinteile  
Nicht für Kinder  
unter 3 Jahren

**WAARSCHUWING**  
Verstikkingsgevaar  
Kleine onderdelen  
Niet voor kinderen  
ouder de 3 jaar

CE EN 71

Product introduction Information produit	Produktkennführung Product introductie	..... P1
Tools you may need Outils dont vous aurez besoin	Hilfsmittel die Sie vielleicht brauchen Gereedschap dat u wellicht nodig heeft	..... P1
Mechanical parts list Liste des parties mécaniques	Liste der mechanischen Teile Lijst van de mechanische onderdelen	..... P1
Plastic parts list Liste des parties plastique	Liste der Kunststoff Teile Lijst van de kunststof onderdelen	..... P2
Gear Box Assembly Composant du moteur	Getriebe Montage Montage van de motor	..... P3
Solar Module Assembly Assemblage du module solaire	Die Solar Modul Montage Montage van het zonnepaneel	..... P5
How to drive the gearbox Comment marche le moteur	Wie man das Getriebe betätigt Hoe u de motor aansluit	..... P6
Solar windmill Eolienne solaire	Solar Windmühle Solar windmolen	..... P9
Solar plane Avion solaire	Solar Flugzeug Solar vliegtuig	..... P12
Solar airboat Hydroglisseur solaire	Solar Propellerboot Solar propellerboot	..... P15
Solar revolving plane Avion solaire tournant	Solar drehende Flugzeug Rotierend vliegtuig	..... P18
Solar puppy Chien solaire	Solar Hündchen Solar puppy hond	..... P21
Solar car Voiture solaire	Solar Auto	..... P21

Product introduction

Produkt Einführung

Information produit

Productintroductie

This is an excellent beginner solar kit, teaching the basic of solar power principles. Learn how it drives the motor and the resulting movement of each model.  
The kit provides a full set of plastic parts, solar panel and all necessary parts to complete the 6 different models.  
Suitable for ages 10 and upwards.

C'est un excellent kit solaire pour apprendre les bases des principes de l'énergie solaire et le fonctionnement du moteur ainsi que le mouvement sur chaque modèle.  
Dans ce kit vous trouverez les parties pour construire les différents modèles avec le panneau solaire. Vous pouvez facilement monter 6 modules différents.  
A partir de 10 ans et plus.

Dies is een uitstekende beginners solar set. Leer de basis van zonne energie. Leer ook hoe zonne-energie de motor aandrijft en de diverse modellen laat bewegen.  
Deze set bevat kunststof onderdelen, een zonnepaneel en alle noodzakelijke onderdelen om 6 verschillende modellen te kunnen maken. Geschikt voor kinderen vanaf 10 jaar.  
Geschikt voor Kinderen ab 10 Jahren aufwärts.

Dit is een uitstekende beginners solar set. Leer de basis van zonne energie. Leer ook hoe zonne-energie de motor aandrijft en de diverse modellen laat bewegen.  
Deze set bevat kunststof onderdelen, een zonnepaneel en alle noodzakelijke onderdelen om 6 verschillende modellen te kunnen maken. Geschikt voor kinderen vanaf 10 jaar.

### Tool you may need

### Hilfsmittel die Sie vielleicht brauchen

### Uutis dont yous auzez besion

### Gereedschap die u wellicht nodig hebt



Cutter  
Pinces  
Tang

### Mechanical parts list

### Liste der mechanischen Teile

### Liste des éléments mécaniques

### Liste van mechanische onderdelen

**P1** Motor with springs  
Moteur mit Springfedern  
Moteur  
Motor met veren

Qty	1
-----	---

**P2** Solarpanel with springs  
Solarpanel mit Springfedern  
Panneau solaire  
Zonnepaneel met veren

Qty	1
-----	---

**P3** Primer gear (red/yellow)  
Antriebsrad (rot/gelb)  
Élément d'entraînement  
Aandrijfontandstel (geel)

Qty	1
-----	---

**P4** Round shaft  
Ronde as  
Axe  
As

Qty	1
-----	---

**P5** Gear with shaft  
Roue avec axe  
Rinnetje met as  
As met aandrijving

Qty	1
-----	---

**P6** Adhesive sponge  
Schuim met plakband  
Bandes adhésives  
Zelfklevend band

Qty	2
-----	---

**P7** 8cm white wire  
Fijn wit draad  
Élément d'entraînement  
Aandrijfontandstel (geel)

Qty	1
-----	---

**P8** 9cm green wire  
Fijn groen draad  
Fijn groen kabel  
9 cm groene kabel

Qty	1
-----	---

**P9** 23cm white wire  
Fijn wit draad  
23 cm witte kabel

Qty	1
-----	---

**P9** 23cm white wire  
Fijn wit draad  
23 cm witte kabel

Qty	1
-----	---

**P10** 23cm green wire  
Fijn groen draad  
23 cm groene kabel

Qty	1
-----	---

**P10** 23cm green wire  
Fijn groen draad  
23 cm groene kabel

Qty	1
-----	---

### Plastic Parts

### Liste des parties plastique

### Kunststoff Teile

### Kunststof onderdelen

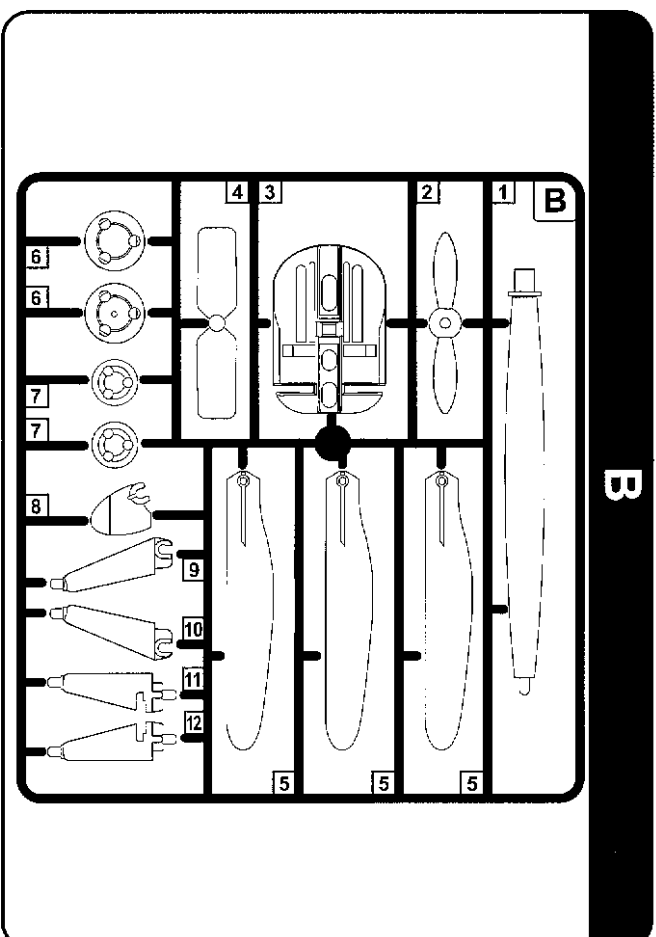
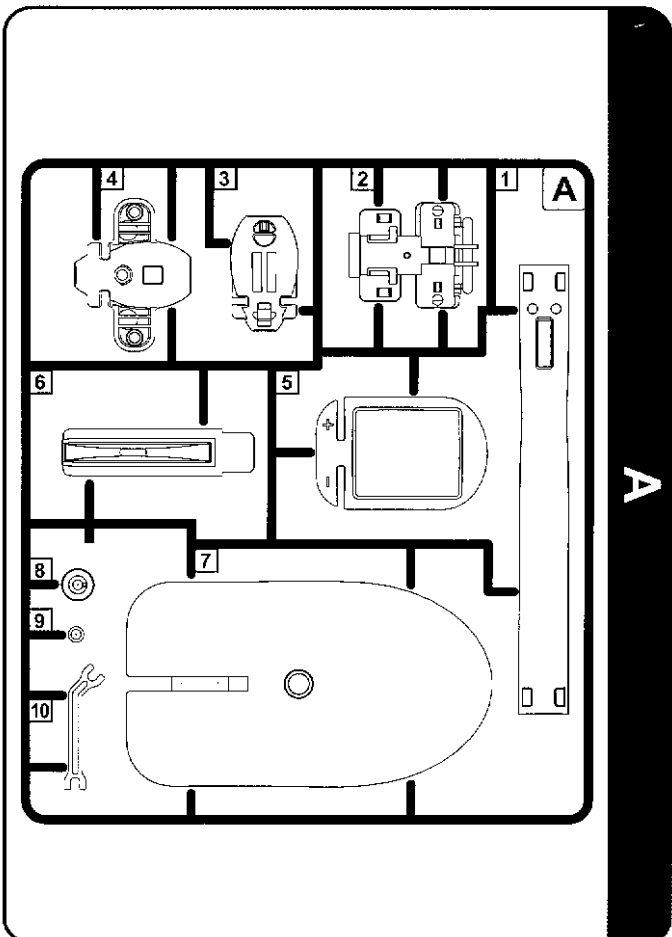

**Gear box assembly**  
Composant du moteur

**Getriebe Montage**  
Montage van de motor

Parts required  
Benoedigde Teile  
Parties nécessaires  
Benodigde onderdelen

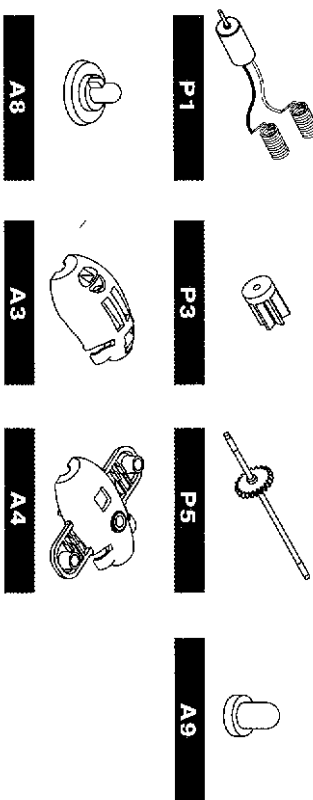

**4**

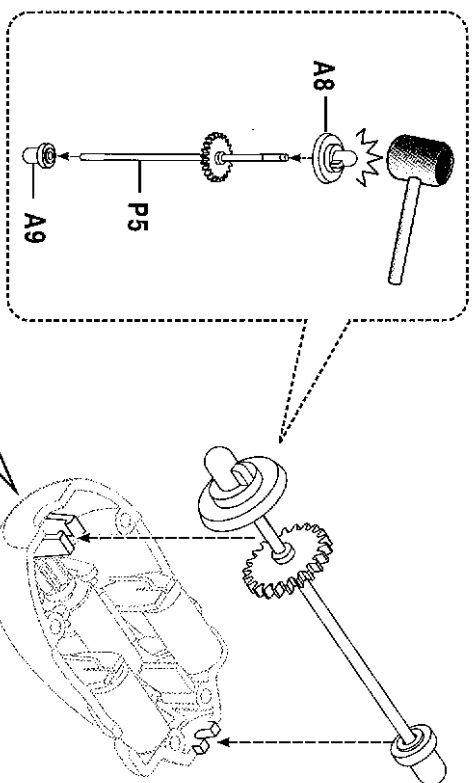

**5**

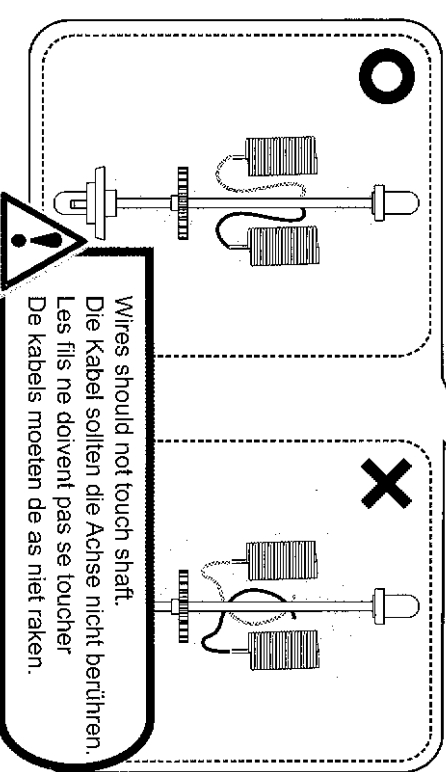

**6**

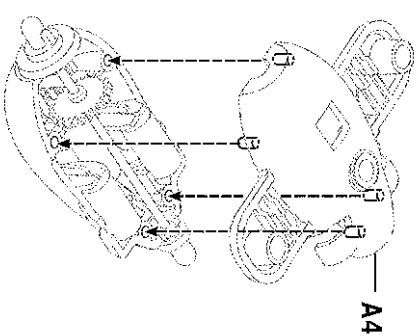

**7**

Finished product !  
Vollendetes Produkt !  
Produit fini !  
Produkt gereed !

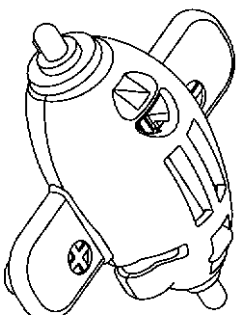

**1**

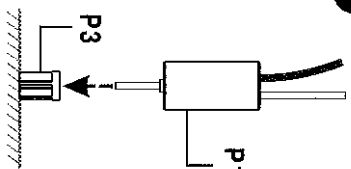

**2**

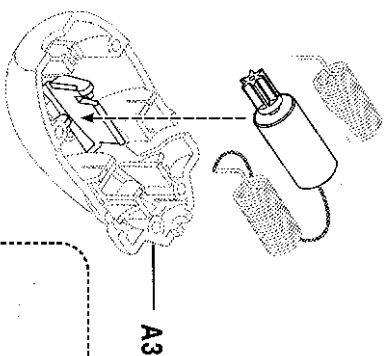

**3**

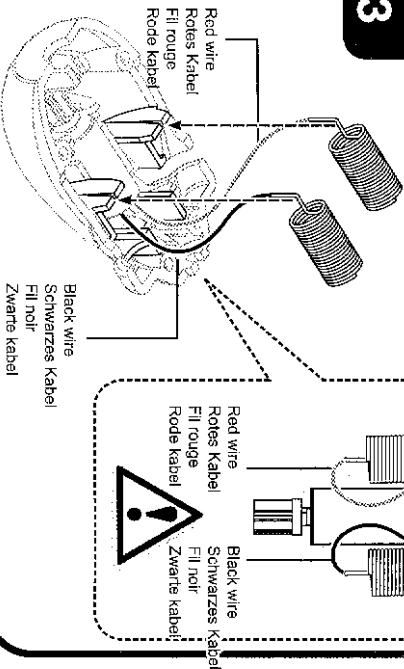

**3**

**4**

Solar module assembly  
Assemblage du module solaire

Die Solar Modul Montage  
Montage van het zonnepaneel

Parts required  
Benoedigde Teile  
Benodigde onderdelen

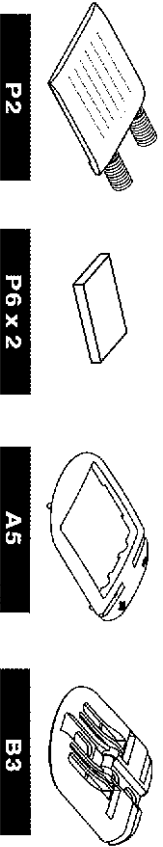

1

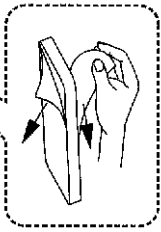

P6x2

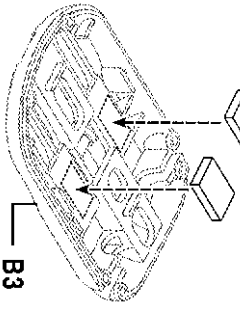

2

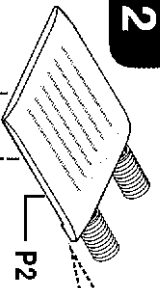

P2

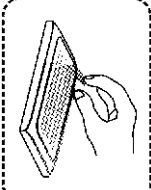

3

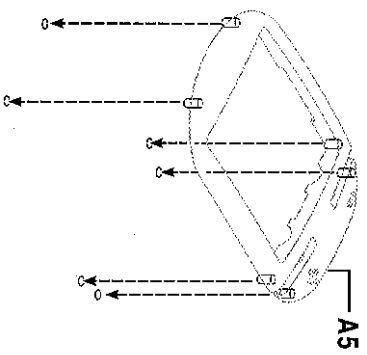

A5

4

Finished product!  
Volleedees Produkt!  
Produkt fertig!  
Produkt gereed!

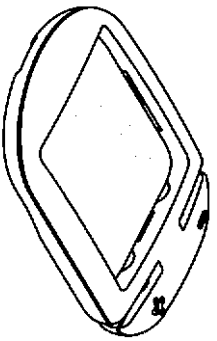

5

How to drive the gear box  
Comment marche le moteur

Wie man das Getriebe betätigt  
Hoe u de motor aansluit

Parts required  
Benoedigde Teile  
Benodigde onderdelen

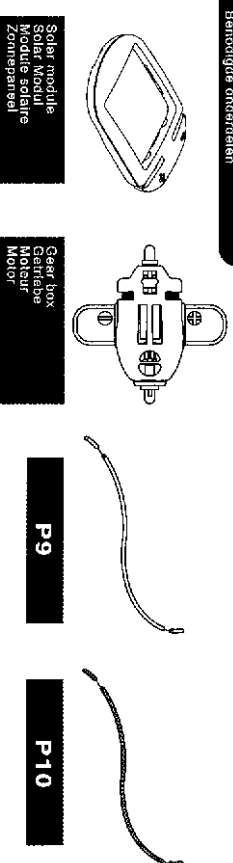

1

Twist stripped wires  
Dreh die Kabelenden  
Enroulez les fils  
Draai de draadeinden

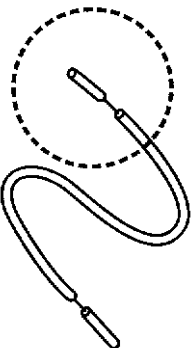

2

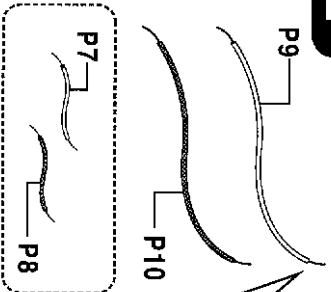

○

×

×

6

3

Solar module  
Solar Modul  
Module solaire  
Zonnepaneel

Connect  
Verbinden  
Connecter  
Verbinden

+

Gear box  
Getriebe  
Moteur  
Motor

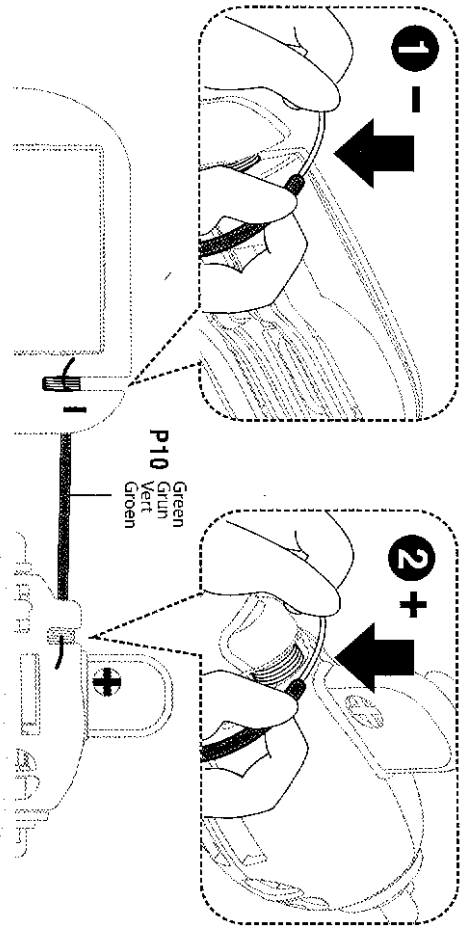

4

Solar module  
Solar Modul  
Module solaire  
Zonnepaneel

Connect  
Verbinden  
Connecter  
Verbinden

+

Gear box  
Getriebe  
Moteur  
Motor

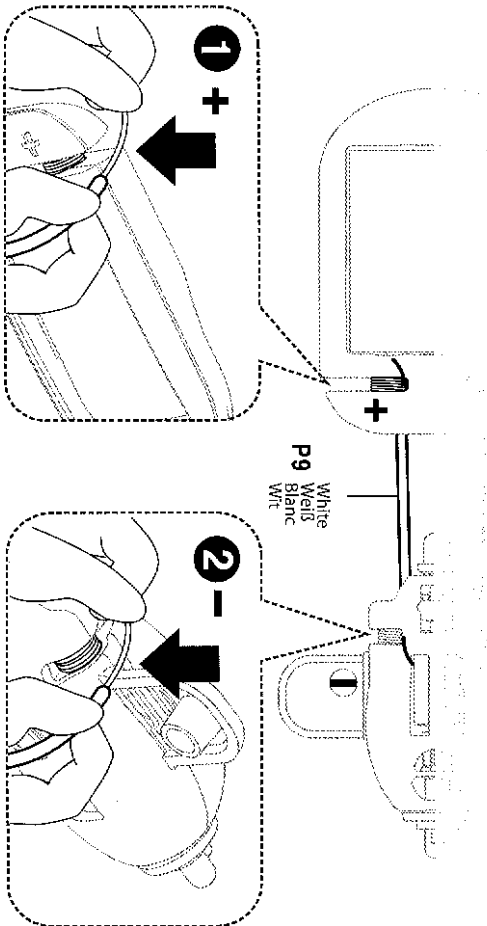

5

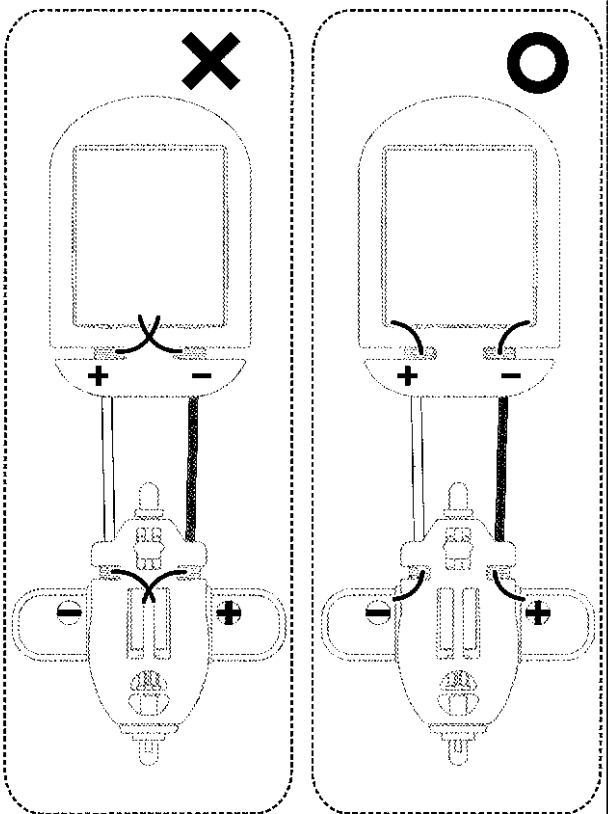

⚠

Wires should not touch each other !  
Die Kabel sollten einander nicht berühren !  
Les fils électriques ne doivent pas se toucher !  
De draden mogen elkaar niet raken !

6

Finished product !  
Vollendetes Produkt !  
Produit fini  
Produkt gereed !

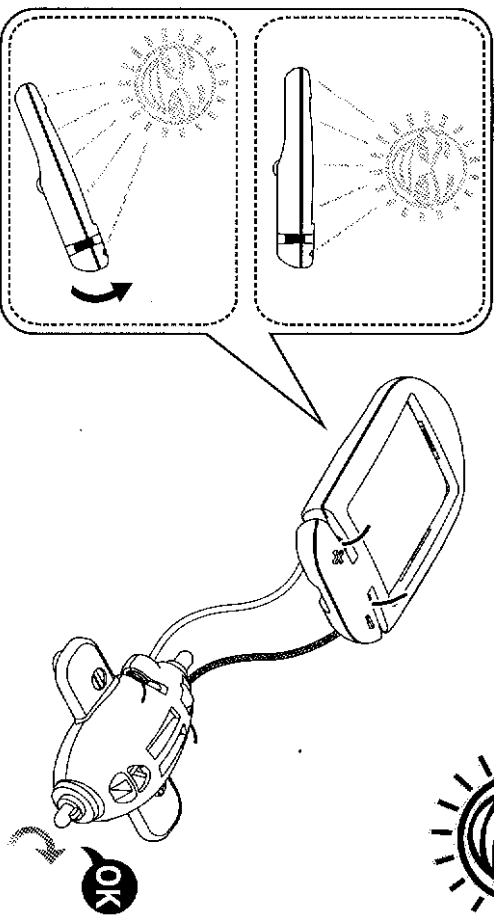

7

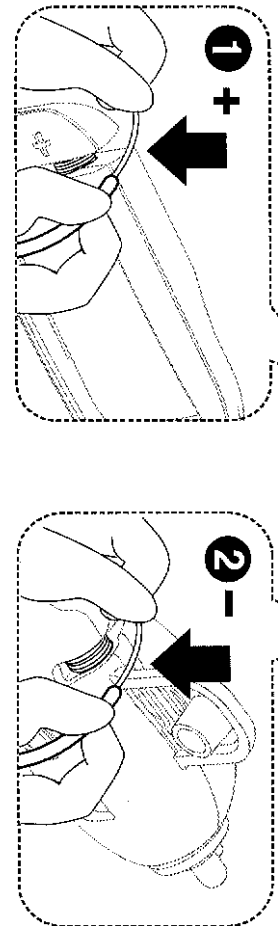

8

Solar Windmill  
Eolienne solaire

Solar Windmühle  
Solar windmolen

Parts required  
Parties nécessaires  
Benodigde onderdelen

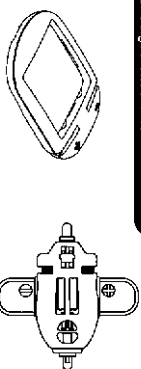

Solar Module  
Solar Modul  
Module solaire  
Zonnepaneel

Gear box  
Getriebe  
Moteur  
Motor

P9

P10



B6

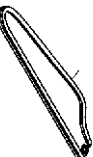

B5x3

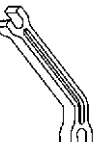

A10



B1



A7

1

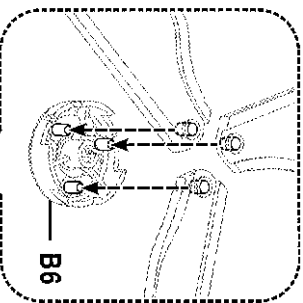

B6

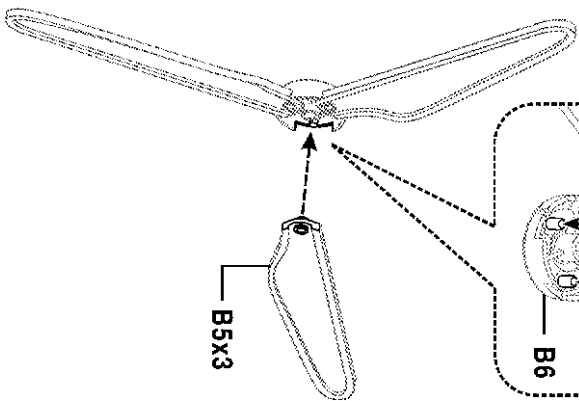

B5x3

2

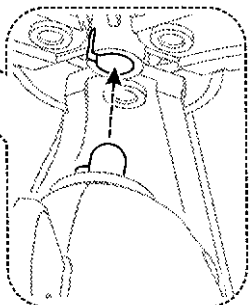

Gear box  
Getriebe  
Moteur  
Motor

3

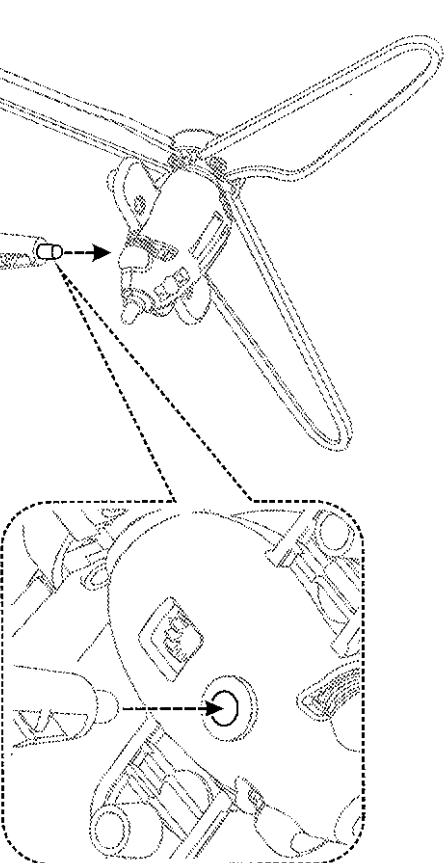

B1

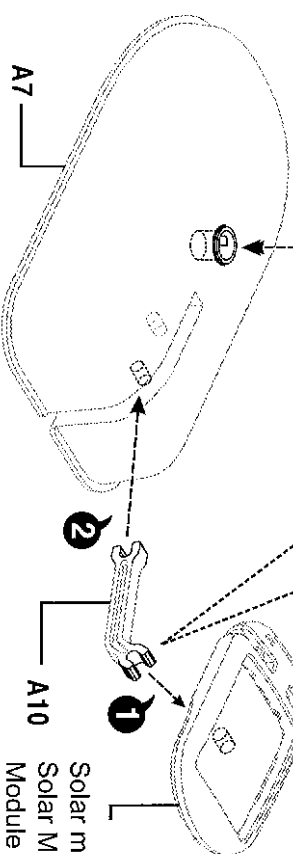

A7

A10

Solar module  
Solar Modul  
Module solaire  
Zonnepaneel

9

10

# Solar plane Avion solaire

# Solar Flugzeug Solar vliegtuig

Parts required  
Parties nécessaires  
Benodigde onderdelen

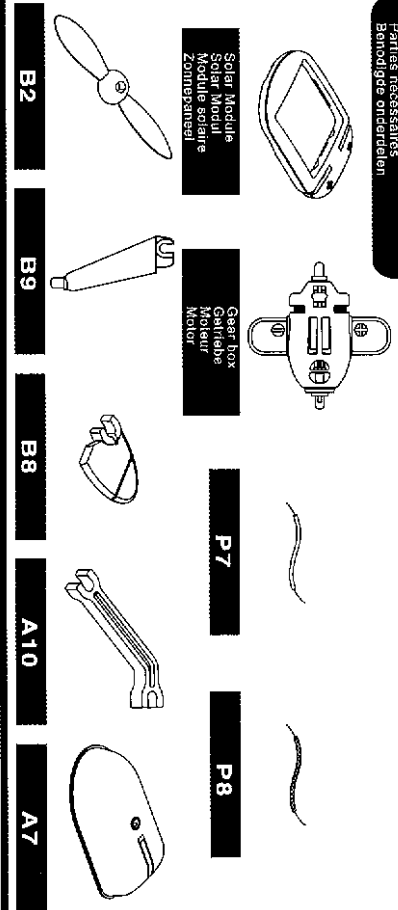

**4**

Solar module  
Solar Modul  
Module solaire  
Zonnepaneel

Connect  
Verbinden  
Connecter  
Verbinden

Gear box  
Getriebe  
Moteur  
Motor

**5**

Solar module  
Solar Modul  
Module solaire  
Zonnepaneel

Connect  
Verbinden  
Connecter  
Verbinden

Gear box  
Getriebe  
Moteur  
Motor

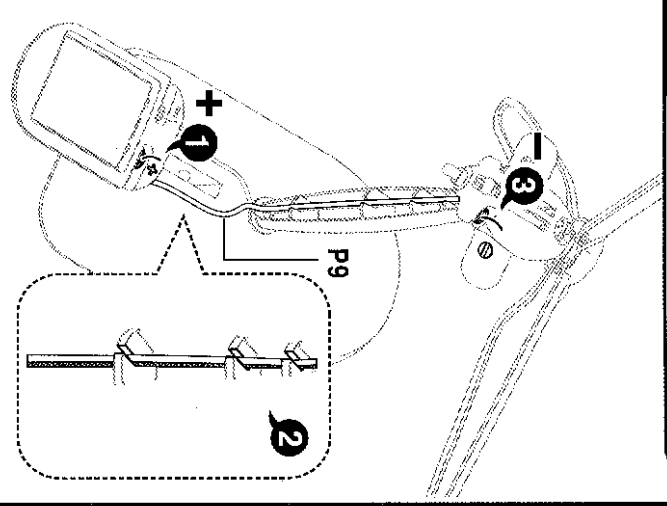
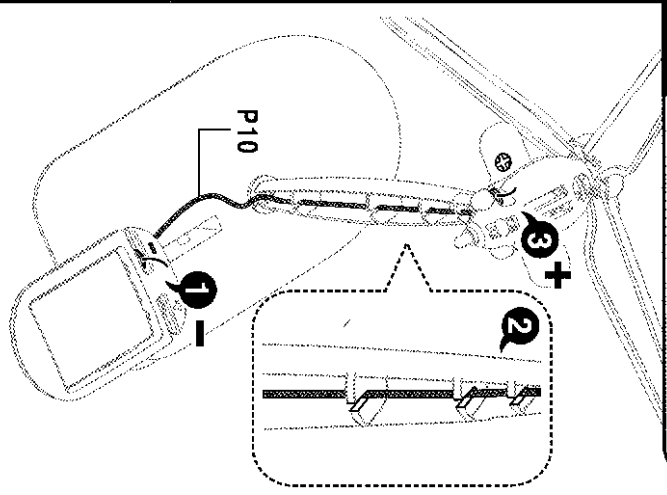

**6**

Finished product!  
Vollendetes Produkt!  
Produit fini!  
Produkt gereed!

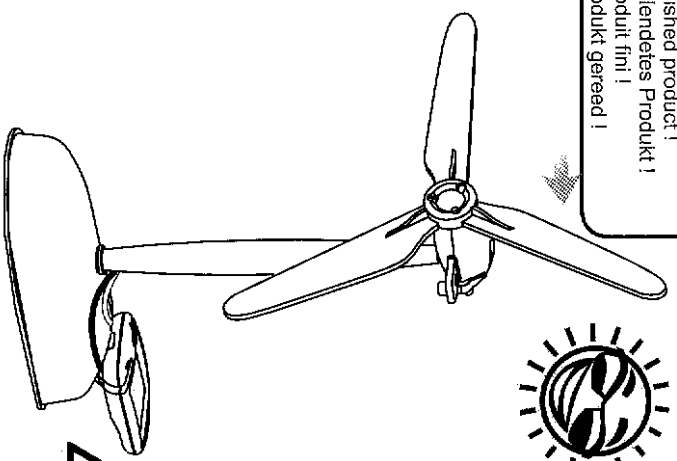

X

Wrong rotation: check steps 4&5  
Bei falscher Drehbewegung  
überprüfen sie die Stufen 4&5  
Mauwaise rotation: vérifiez les  
étapes 4&5  
Verkeerde draairichting: controleer  
stap 4&5

**1**

B2

Gear box  
Getriebe  
Moteur  
Motor

B8

**2**

B9

A7

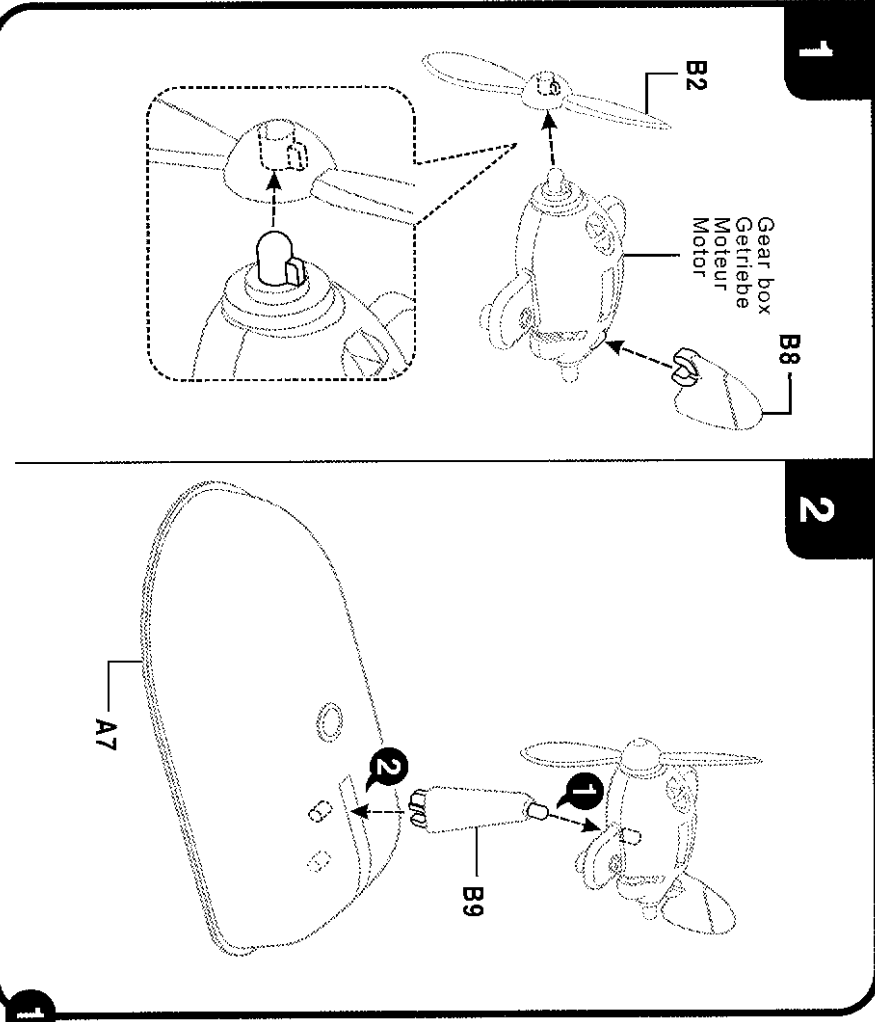

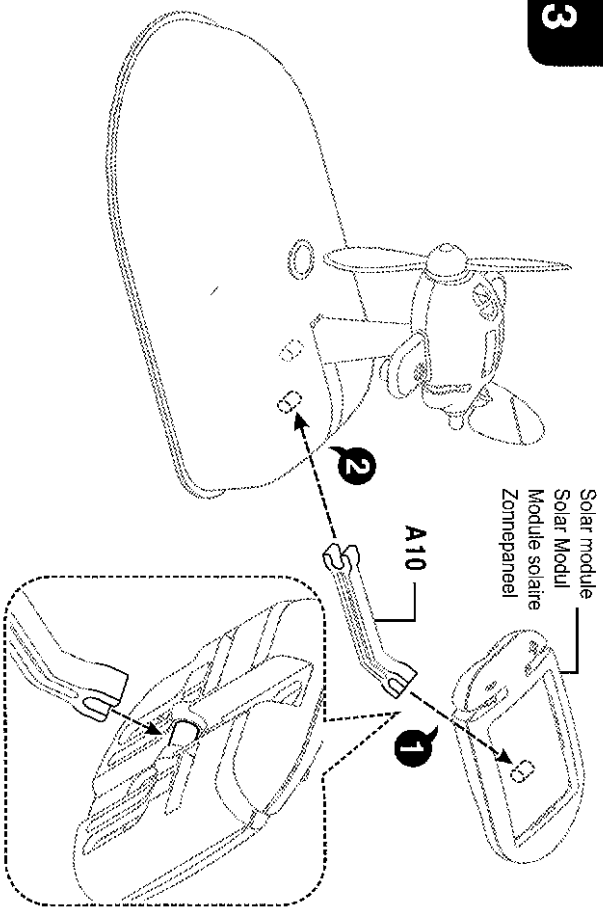

Solar module / Solar Modul / Module solaire / Zonnepaneel

Connect / Verbinden / Connecter / Verbinden

Gear box / Gèrriehje / Motor

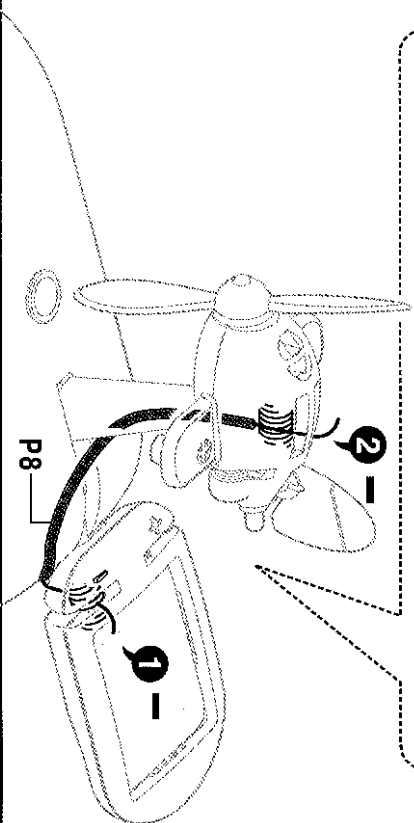
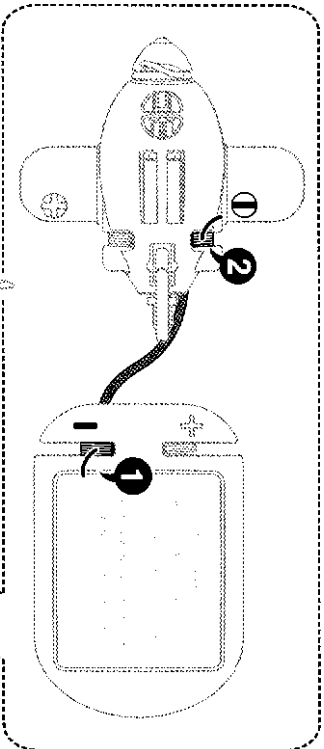

Solar module / Solar Modul / Module solaire / Zonnepaneel

Connect / Verbinden / Connecter / Verbinden

Gear box / Gèrriehje / Motor

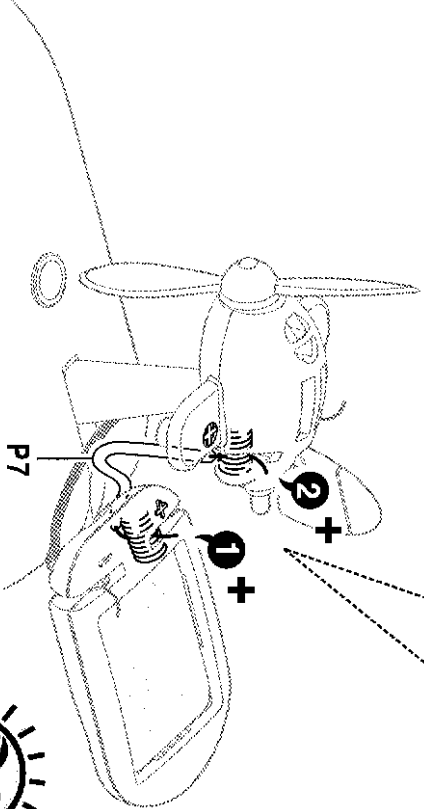
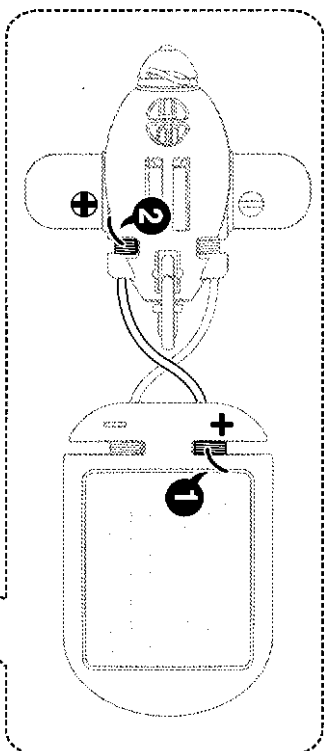

6

Finished product !  
Vollendetes Produkt !  
Produit fini !  
Produkt gereed !

You may also use B4  
to replace B2  
Sie können außerdem B4  
nutzen um B2 zu ersetzen  
Vous pouvez utiliser B4  
à la place de B2  
U kunt ook B4 gebruiken om  
B2 te vervangen

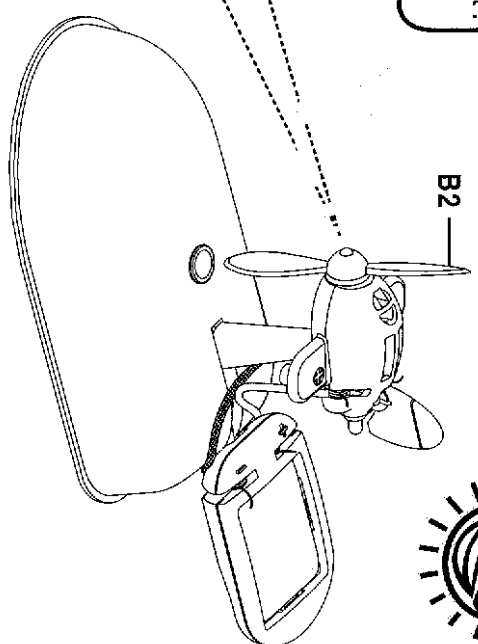

# Solar airboat Hydroglisseur solaire

# Solar Propellerboat Solar propellerboot

Parts required  
Parties nécessaires  
Benodigde onderdelen



Solar Module  
Solar Modul  
Module solaire  
Zonnepaneel

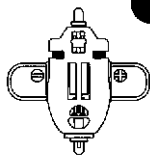

Gear box  
Getriebe  
Moteur



P7



P8

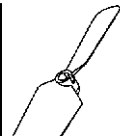

B4

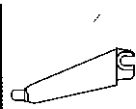

B9

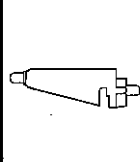

B11

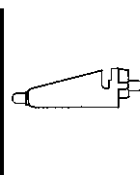

B12



B8

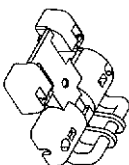

A2

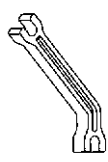

A10



A7

## 3

Solar module  
Solar Modul  
Module solaire  
Zonnepaneel

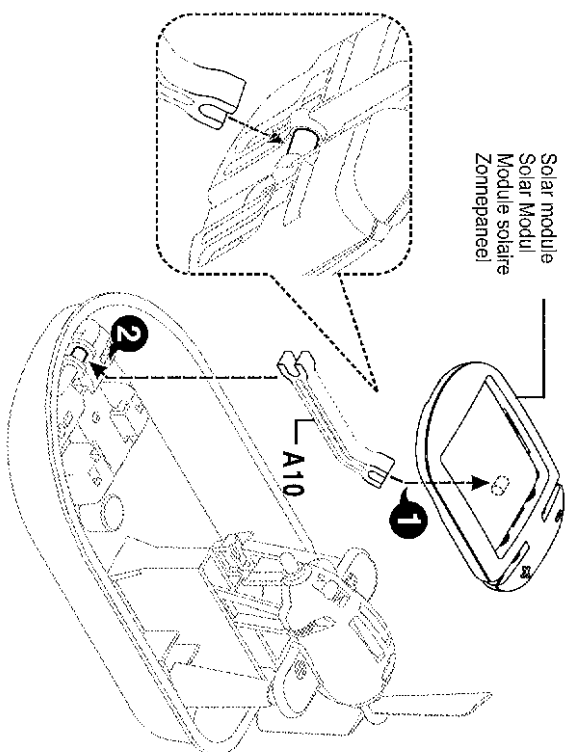

## 4

Solar module  
Solar Modul  
Module solaire  
Zonnepaneel

+

Connect  
Verbinden  
Connexer  
Verbinden

+

Gear box  
Getriebe  
Moteur

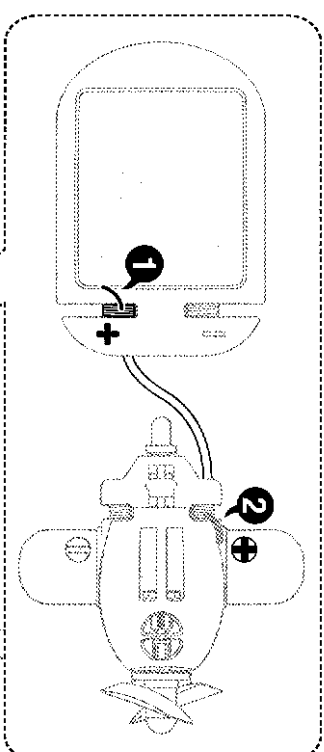

## 1

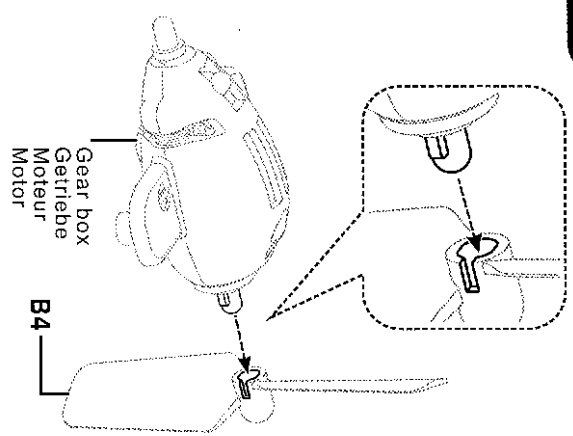

## 2

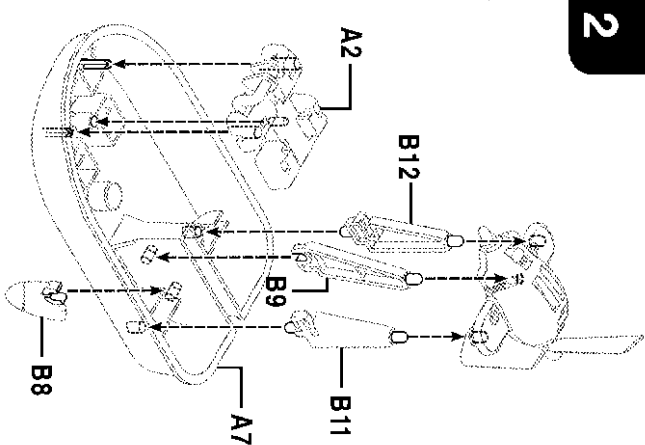

## 15

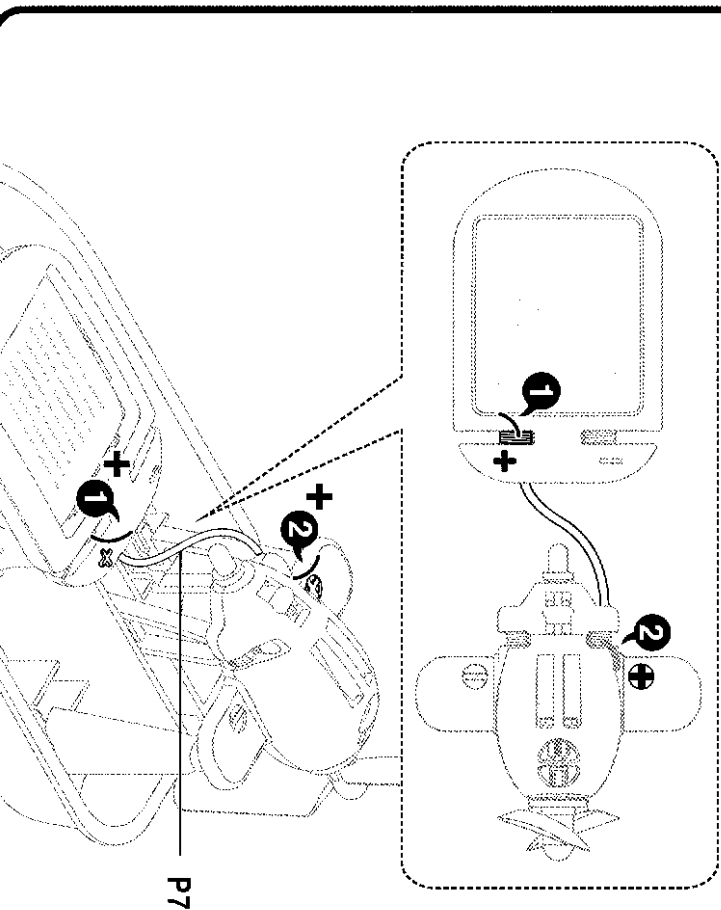

## 16

- Solar module  
Solar Modul  
Module solaire  
Zonnepaneel
- Connect  
Verbinden  
Connecter  
Verbinden
- Gear box  
Géboîte  
Moteur  
Motor

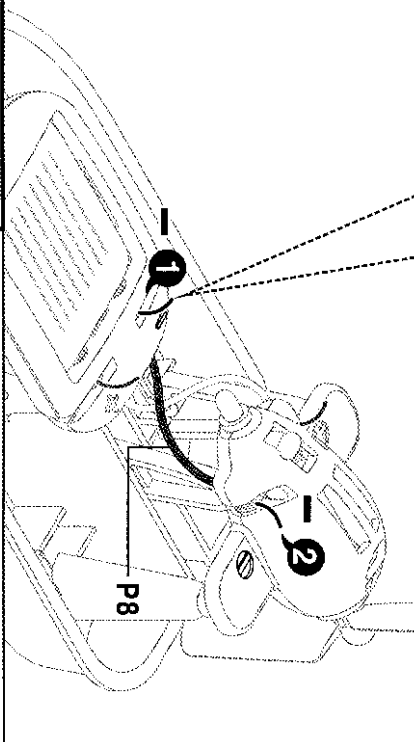
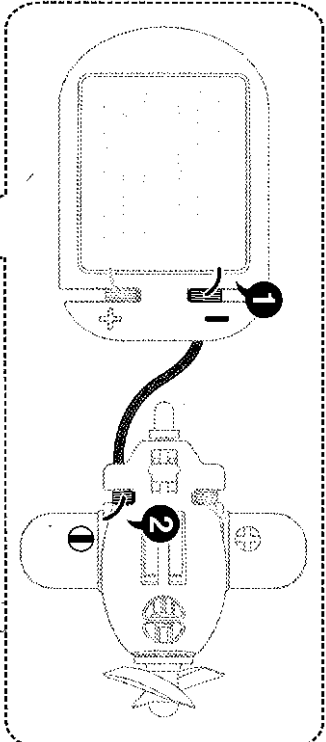

**6**  
 Finished product!  
 Vollendetes Produkt!  
 Produit fini!  
 Produkt gereed!

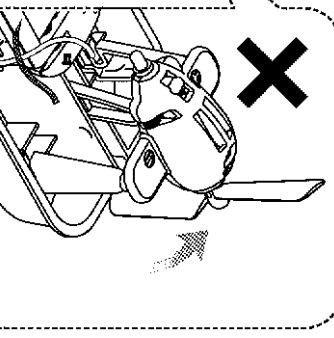
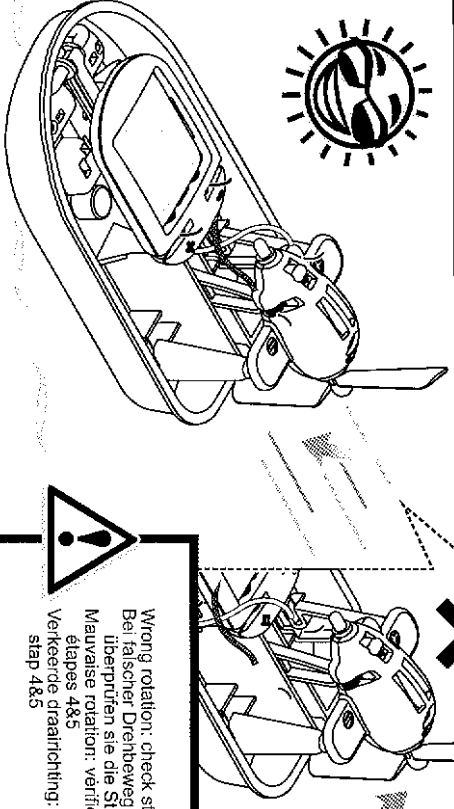

Wrong rotation: check steps 4&5  
 Bei falscher Drehbewegung  
 überprüfen sie die Stufen 4&5  
 Mauvaise rotation: vérifiez les  
 étapes 4&5  
 Verkeerde draairichting: controleer  
 stap 4&5

Solar Revolving Plane  
 Avion solaire tournant

Solar drehende Flugzeug  
 Rotierend vliegend

Parts required  
 Besorgte Teile  
 Parties nécessaires  
 Benodigde onderdelen

- |  |  |     |  |
|--|--|-----|--|
|  |  |     |  |
| Solar Module<br>Solar Modul<br>Module solaire<br>Zonnepaneel | Gear box<br>Géboîte<br>Moteur<br>Motor | P9  | P10  |
|  |  |     |  |
| B2   | B8                                     | A10 | Coin (not included)<br>Münze<br>(nicht eingeschlossen)<br>Pièce (not fournie)<br>Munt (niet bijgeleverd) |
|  |  |     |  |
| A7   | A6                                     | A1  |  |

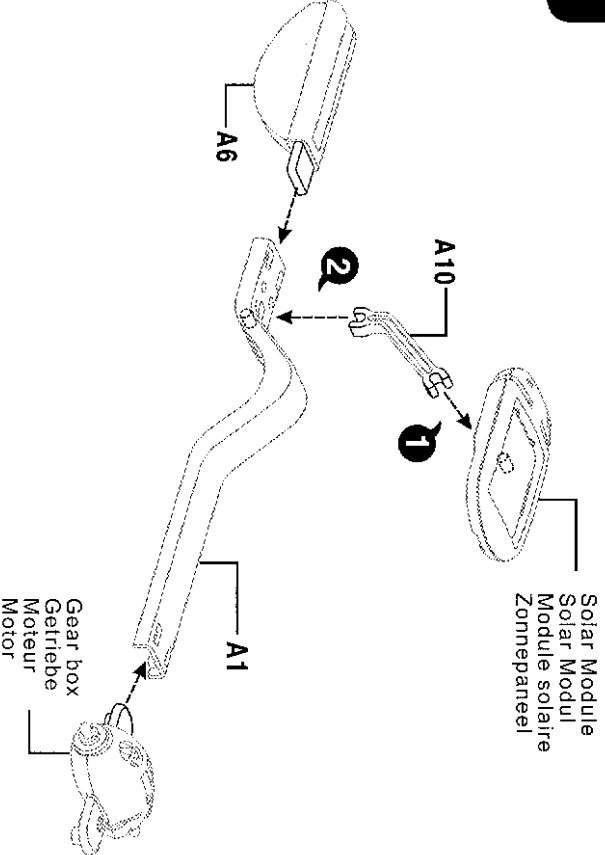

Solar Modul  
 Module solaire  
 Zonnepaneel

Gear box  
 Géboîte  
 Moteur  
 Motor

Solar module  
Solar Modul  
Module solaire  
Zonnepaneel

Connect  
Verbinden  
Connecter  
Verbinden

Gear box  
Gehäuse  
Moteur  
Moteur

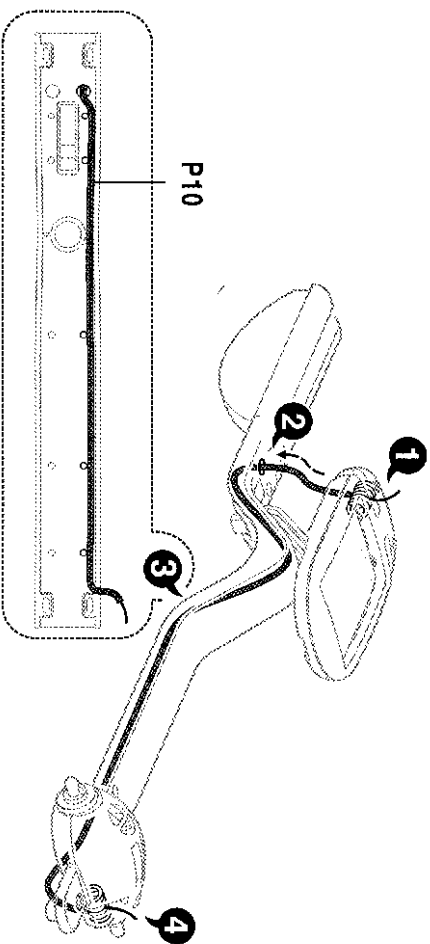

Solar module  
Solar Modul  
Module solaire  
Zonnepaneel

Connect  
Verbinden  
Connecter  
Verbinden

Gear box  
Gehäuse  
Moteur  
Moteur

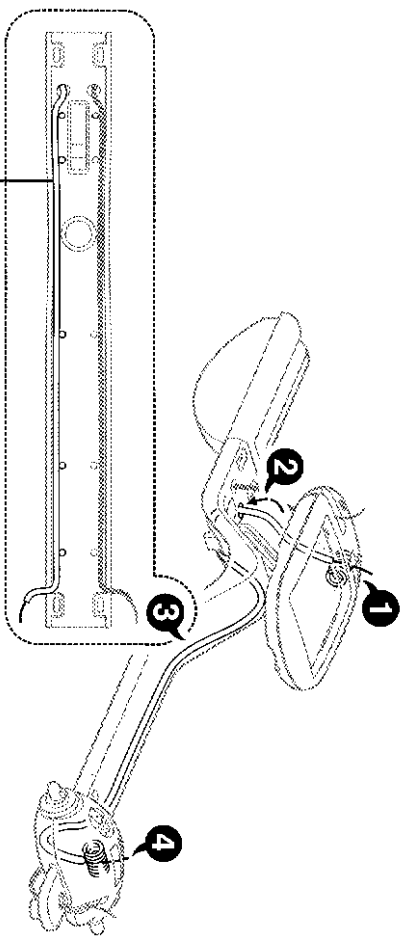

How to play  
Wie man spielt  
Comment jouer  
Hoe je speelt

Insert coin  
Werfen Sie eine Münze ein  
Insérer la pièce  
Werp een munt in

Adjust solar module to balance the lever.  
Stellen Sie die Solar Modul ein um zu balanzieren  
Positionner le module solaire pour équilibrer le kit  
Pas het zonnepaneel aan voor de juiste balans

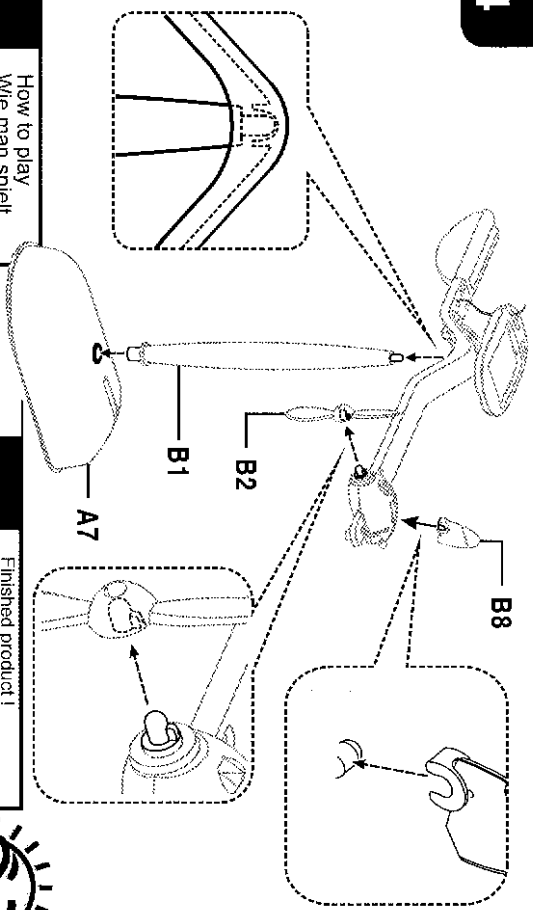

Finished product !  
Vollendetes Produkt !  
Produit fini !  
Produkt gereed !

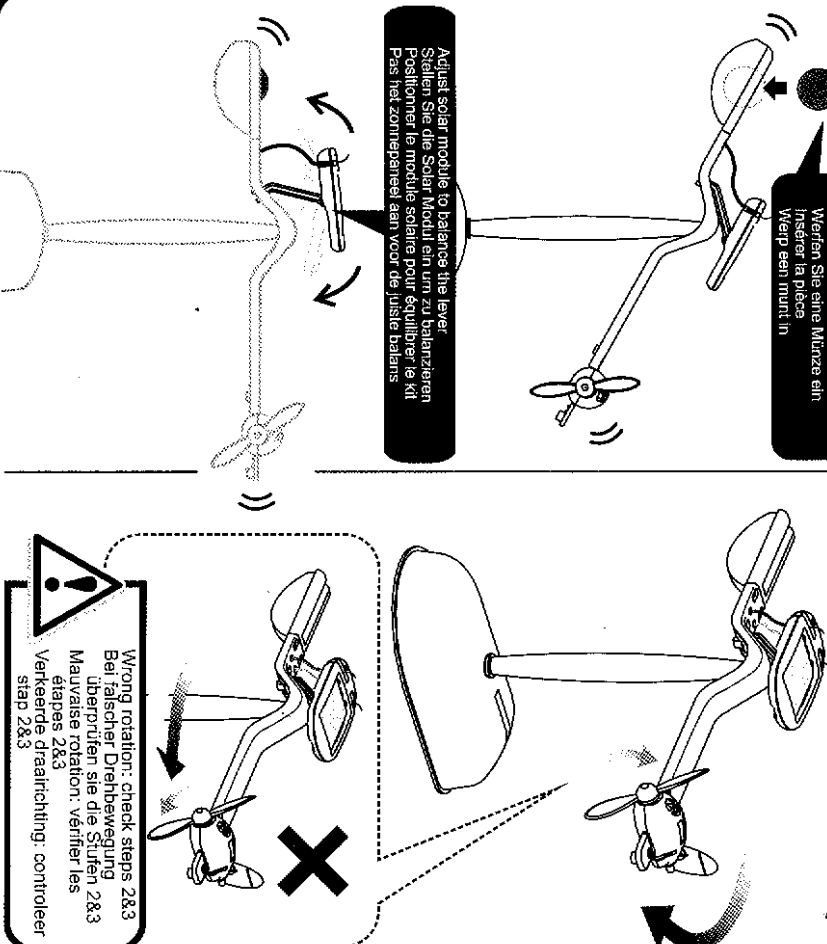

Wrong rotation: check steps 2&3  
Bei falscher Drehbewegung  
Überprüfen sie die Stufen 2&3  
Mauvaise rotation: vérifiez les  
étapes 2&3  
Verkeerde draairichting: controleer  
stap 2&3

Solar puppy  
Chien solaire

Solar Hündchen  
Solar puppy hond

Parts required  
Parties nécessaires  
Benodigde onderdelen

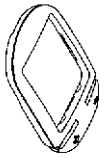

Solar Module  
Solar Modul  
Module solaire  
Zonnepaneel

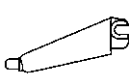

B9

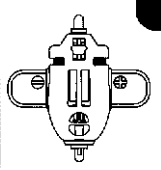

Gear box  
Getriebe  
Moteur  
Motor



B10



P7

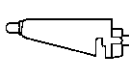

B11



P8

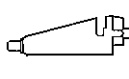

B12



B8

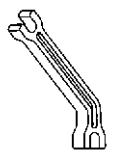

A10

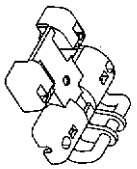

A2

1

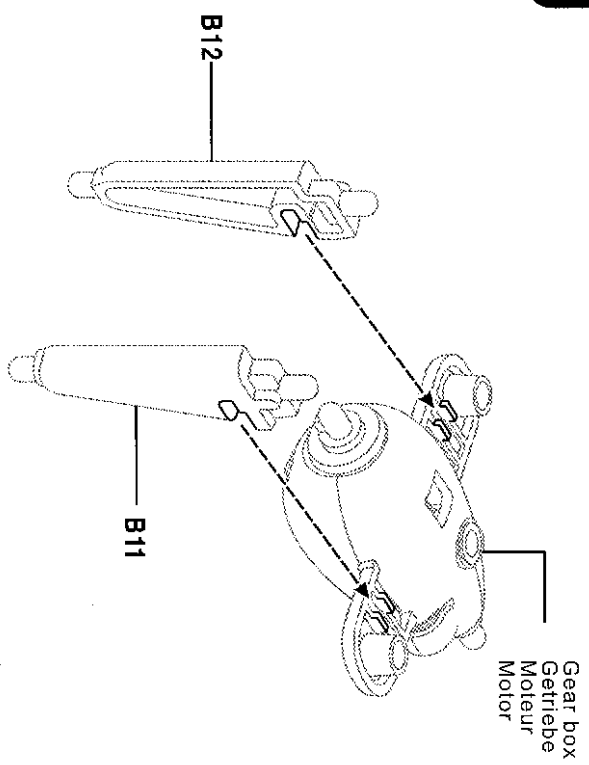

3

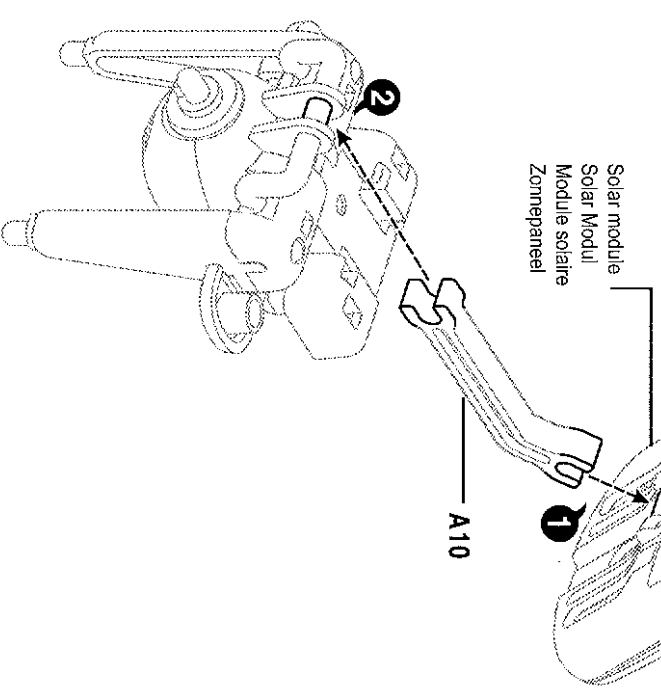



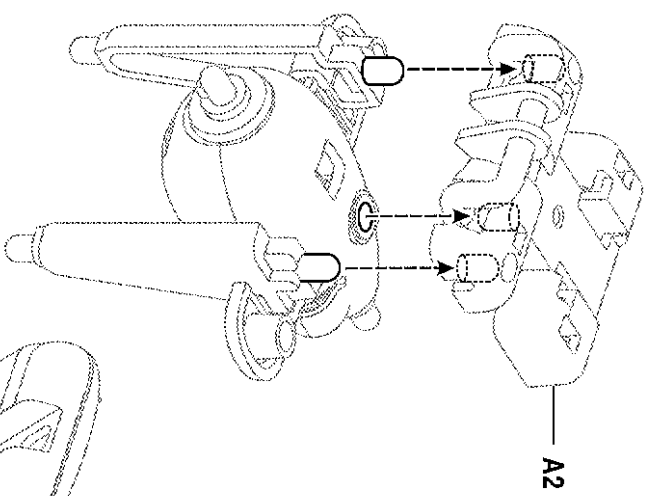





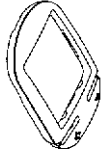
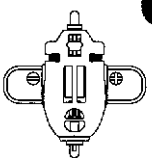

2

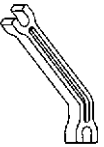
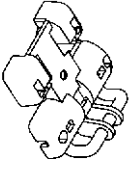

Solar car  
Voiture solaire

Solar Auto  
Solar auto

Parts required  
Benodigde Teile  
Parties nécessaires  
Benodigde onderdelen

- |   |   |   |   |
|---|---|---|---|
|  |  |  |  |
| Solar Module<br>Solar Module<br>Module solaire<br>Zonnepaneel                         | Gear box<br>Getriebe<br>Moteur  | P7  | P8  |
|  |  |  |  |
| P4  | B7x2  | B6x2  | A10   |
|    |    |    |    |
| A2  | A2  | A2  | A2  |

4

Solar module Solar Modul Module solaire Zonnepaneel	+	Connect Verbinden Conectar Verbinden	+	Gear box Getriebe Moteur
	-	Connect Verbinden Conectar Verbinden	-	

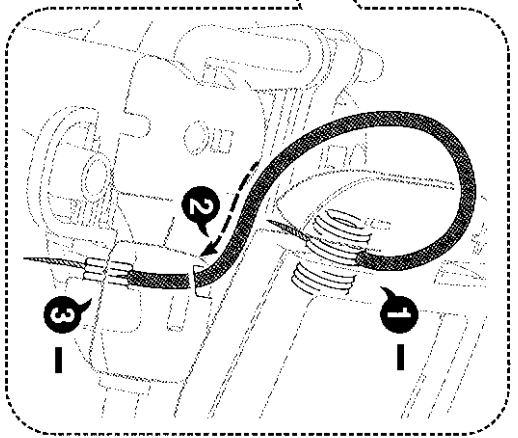
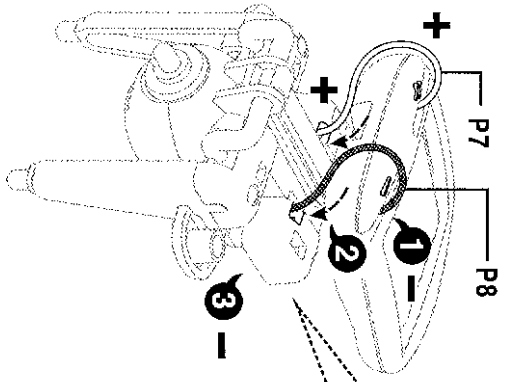

5

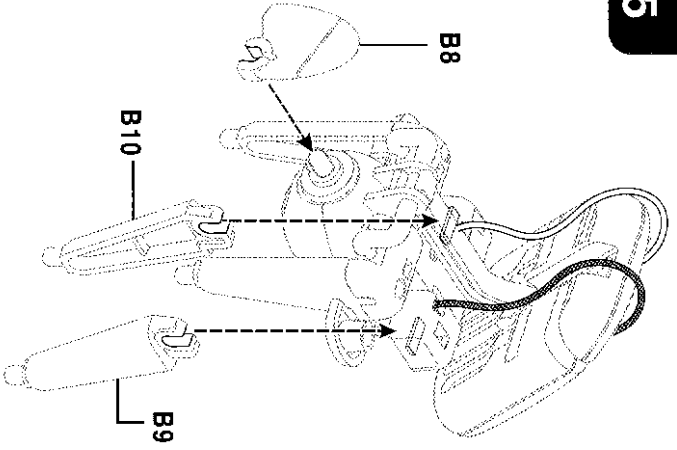

6

Finished product!  
Voilàndetes Produkt!  
Produit fini!  
Produkt gereed!

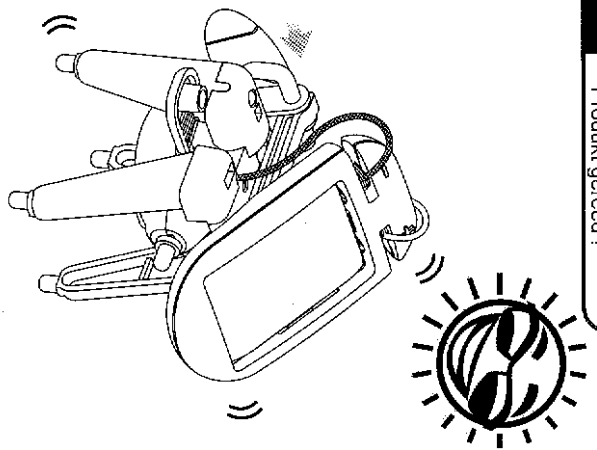

1

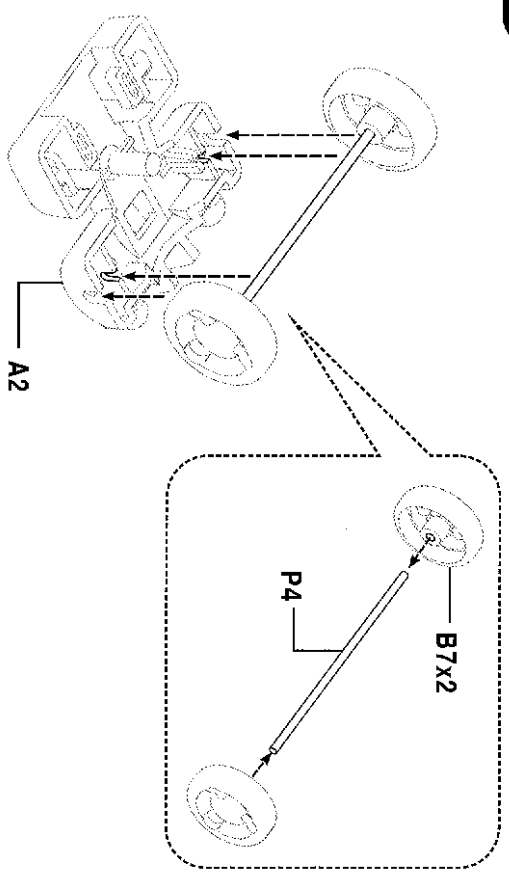

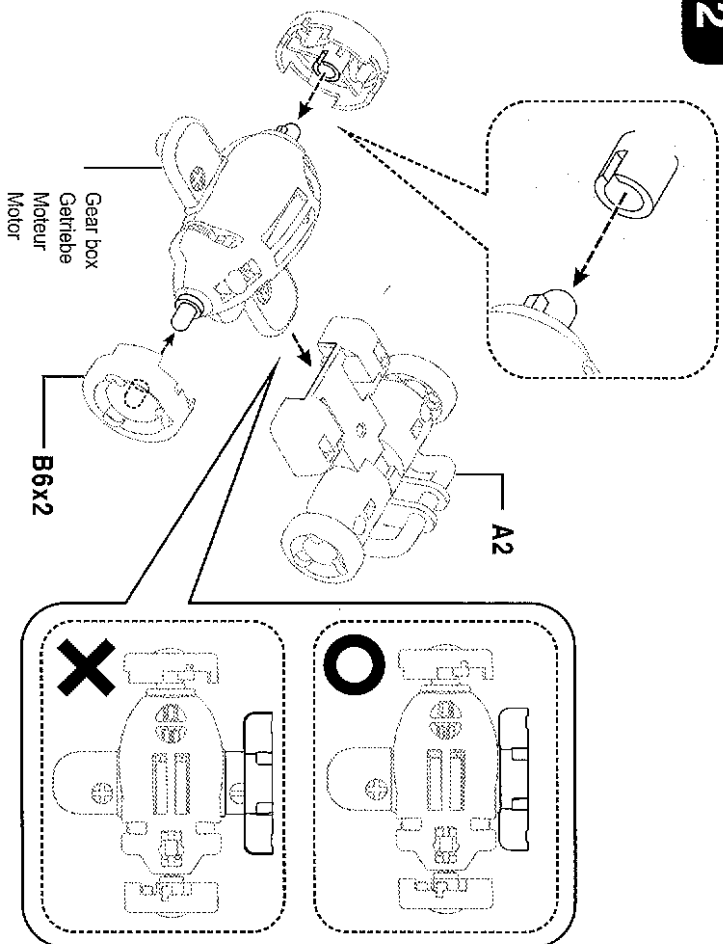

Solar module Solar Modul Module solaire Zonnepaneel	Connect Verbinden Connecter Verbinden	+	Connect Verbinden Connecter Verbinden	+	Gear box Getriebe Moteur Motor
--	--	---	--	---	---

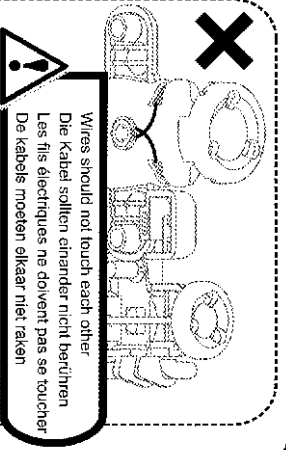
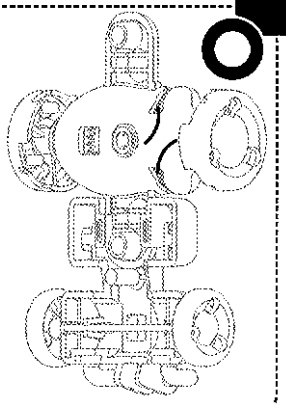
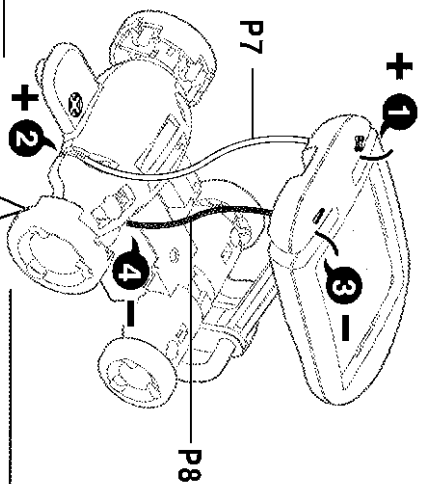

**Warning!**  
Wires should not touch each other  
Die Kabel sollen einander nicht berühren  
Les fils électriques ne doivent pas se toucher  
De kabels moeten elkaar niet raken

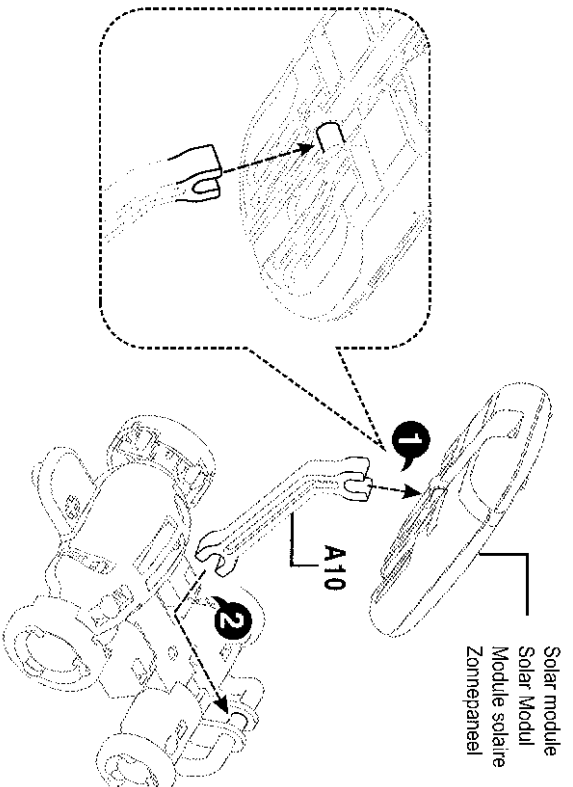

**Finished product!**  
Vollendetes Produkt!  
Produkt klaar!  
Product gereed!

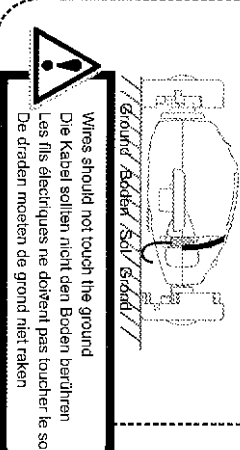
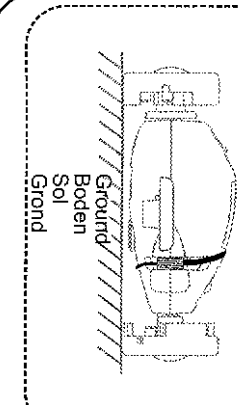

**Warning!**  
Wires should not touch the ground  
Die Kabel sollen nicht den Boden berühren  
Les fils électriques ne doivent pas toucher le sol  
De draden moeten de grond niet raken

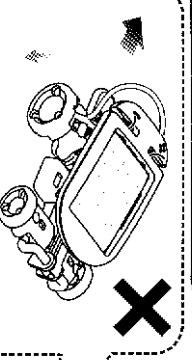

**Wrong rotation, check steps 4&5**  
Bei falscher Drehbewegung  
überprüfen sie die Stufen 4&5  
Mauvaise rotation: vérifiez les  
étapes 4&5  
Verkeerde draairichting: controleer  
stap 4&5



It's time to have some fun !  
Amusez vous bien !

Es ist Zeit ein bisschen Spaß zu haben!  
Het is tijd voor plezier !

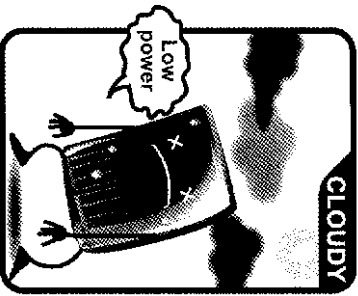
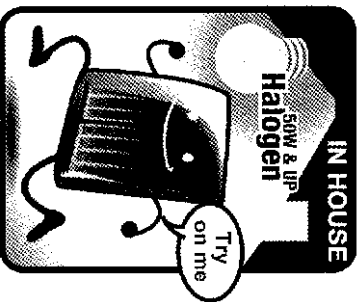
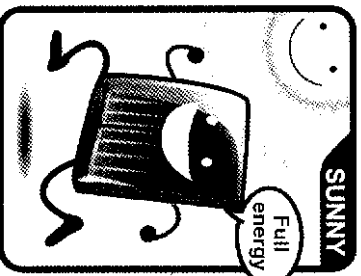

Take outside under direct sunlight.  
Best results are obtained when operated on a sunny day.  
For indoor fun, use a 50 Watt halogen light.  
The product will not run on a cloudy day,  
shaded locations, indirect sunlight or under fluorescent light.

Bringen Sie es nach draußen in die direkte Sonne, die besten Resultate werden erzielt wenn man an einem sonnigen Tag arbeitet.  
Für Spaß im Inneren nutzen Sie eine 50 Watt Halogen Lampe. Diese Produkt wird an einem bewölkten Tag, an einem schattigen Tag, im indirekten oder im fluoreszierenden Licht nicht funktionieren.

Amenez le produit sous le soleil. Les meilleurs résultats sont obtenus avec une journée ensoleillée. Pour jouer à l'intérieur, utiliser une lampe halogène de 50 watts. Ce produit ne fonctionnera pas par temps couvert, à l'ombre, avec une source de lumière indirecte ou sous une lampe fluorescente.

Neem het model dat u heeft gemaakt naar buiten onder direct zonlicht. Het beste resultaat bereikt u op een zonnige dag.  
Voor gebruik binnen, gebruik een 50 Watt halogeen lamp. Het product werkt niet op bewolkte dagen, schaduwrijke locaties, indirect zonlicht of onder fluorescent licht.

**POWERplus®**

**6 in 1**  
EDUCATIONAL  
SOLAR KIT

**POWERplus®**  
CHAMELEON

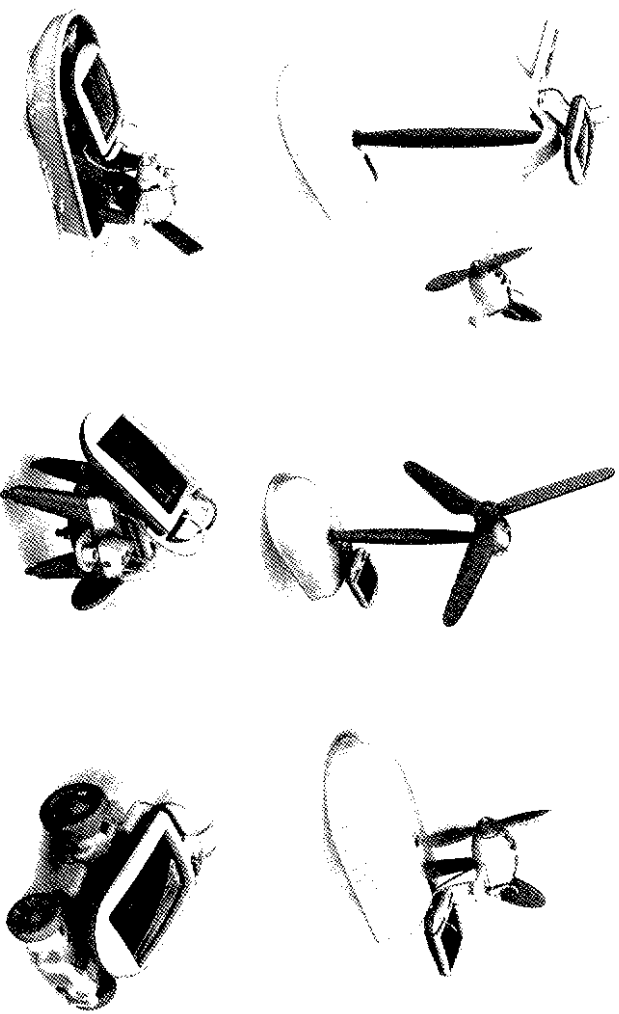

**WARNING**  
Choking hazards  
Small parts  
Not for children  
under 3 years

**ATTENTION**  
Contient des éléments  
de petite taille. Ne  
convient pas aux enfants  
moins de 3 ans.

**WARNUNG**  
Erststckungsgefahr  
Kleinteile  
Nicht für Kinder  
unter 3 Jahren

**WAARSCHUWING**  
Verstikkingsgevaar  
Kleine onderdelen  
Niet voor kinderen  
ouder de 3 jaar